



24" IPS Monitor

S2424i

USER MANUAL



# CONTENTS

Notices **01**

Product  
Introduction **02**

Installation **03**

Adjusting the  
Monitor **04**

Usage **05**

OSD Menu **06**

Basic  
Parameters **07**

---

*Before using this product, please read this User Manual carefully and keep it well*







- Keep the monitor away from water sources or damp places, such as bath rooms, kitchens, basements and swimming pools.
  - Make sure the monitor is placed on a flat surface. If the monitor falls down, it may cause human injury or device damage.
  - Store and use the monitor in a cool, dry and well ventilated place, and keep it away from emission and heat sources.
  - Do not cover or block the vent hole in the rear casing, and do not use the product on a bed, sofa, blanket or similar objects.
  - The range of the supply voltage of the monitor is printed on the label on the rear casing. If it is impossible to determine the supply voltage, please consult the distributor or local power company.
  - If the monitor will not be used for a long period, please cut off the power supply to avoid electric shock in rainy days and damage due to abnormal supply voltage.
  - Please use a reliable earthing socket, do not overload the socket, or it may cause fire or electric shock.
  - Do not put foreign matters into the monitor, or it may cause short circuits resulting fire or electric shock.
  - Do not disassemble or repair this product by self to avoid electric shock. If faults occur, please contact the after-sales service directly.
  - Do not pull or twist the power cable forcedly.
  - There is a polarizer layer (not a protective film) on the surface of the screen. Do not peel it off, or the product may be damaged and the warranty will be invalid.
-

# PRODUCT INTRODUCTION

# 02

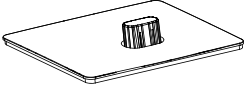
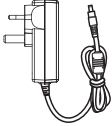
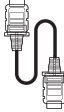
## Package list

- Please check that the package of the monitor contains all parts. If any part is lost, please contact the distributor.
- The color and shape of parts may vary with models. Figures in this User Manual are for reference only.
- Wires supplied may vary with purchased products. Figures in this User Manual are for reference only.

 <p>Monitor</p>	 <p>Stand</p>	 <p>Base</p>
 <p>Adapter</p>	 <p>HDMI signal cable</p>	 <p>Wall-Mount Spacers (4pcs)</p>
 <p>VGA signal cable</p>	 <p>Instructions</p>	

\*Redundant screws can be used as spare screws.



## Installation of base

1. Take out the Stand Neck and base, and assemble the base with a neck until you hear a click sound.

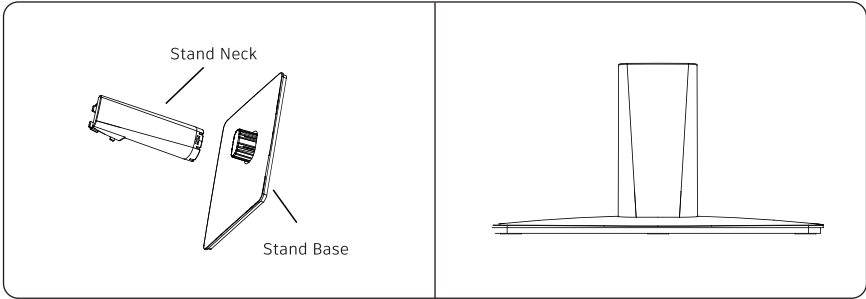

2. Install the assembled stand to the back of the monitor until you hear a click sound.

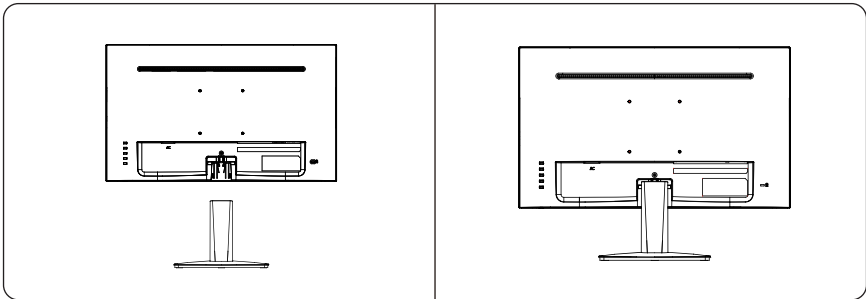

3. After assembly, simply hold the stand with hand to stand the monitor upright.

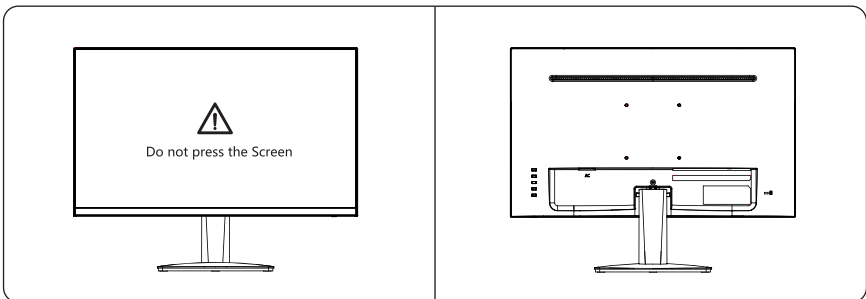

**Note:** During standing of the whole monitor, do not press the liquid crystal screen with hand to avoid damage to the screen.

# ADJUSTING THE MONITOR

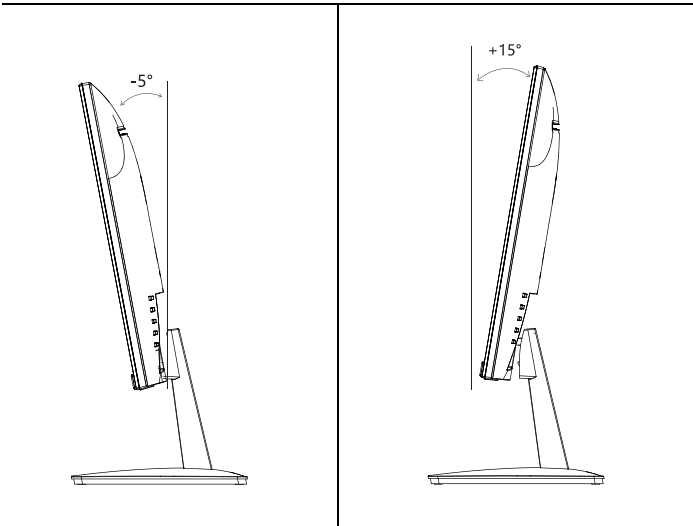
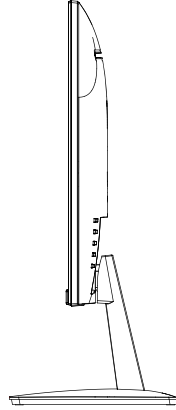

## Tilting angle

-5.0°(±2.0°)- +15°(±2.0°)

## Description of buttons

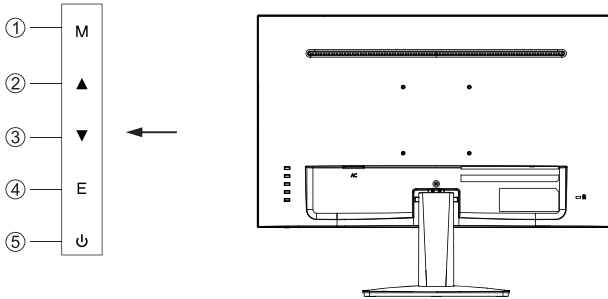

Button	Function
M	Menu button: Press to enter sub-menus/ quickly enter the main menu
▲	Up button: Press to move up in the menu/quickly volume hot key
▼	Down button: Press to move down in the menu/quickly brightness hot key
E	Exit/Signal selection; Long press the "AUTO" button under VGA signal source to adjust the image automatically
⏻	Power button: Press to turn on/off the monitor

## Explanation of indicators

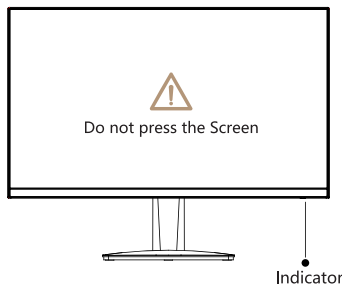

Indicator: Steady blue light indicates the power is on and the monitor runs normally. Steady red light indicates no video source and no horizontal or vertical signal detected or low voltage. Please make sure your computer is turned on and all video cables are fully plugged in and/or connected.

# Cable connection:

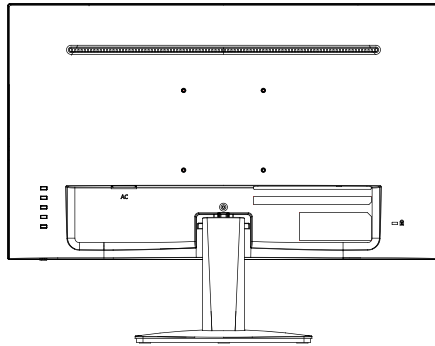

- The bottom interface configuration at the back of the monitor varies with products.
- Note: If the power cable or signal cable is damaged, you must replace it with special soft cables or special components purchased from the manufacturer or maintenance department.

## HDMI interface

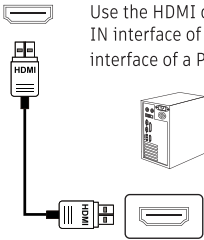

Use the HDMI cable to connect the HDMI 1/2 IN interface of the product to the HDMI OUT interface of a PC.

## VGA Interface

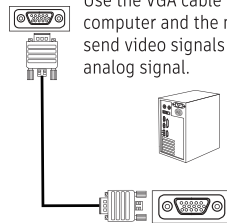

Use the VGA cable to connect the computer and the monitor to send video signals by an analog signal.

## Power Adapter

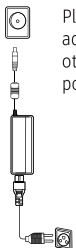

Please connect the power adapter to the power adapter interface of a monitor, and plug the other end of the power cable into the power socket.

## Menu description

- The color and shape of the OSD menu of the actual computer may be slightly different from them shown in the figure.
- Specifications of the OSD menu may change with improvements of functions without prior notice.

The screen display (OSD) menu can be used to adjust settings of the monitor and is shown on the screen after the monitor is powered on and the M button is pressed.

1. Press one of the buttons ( M ▲ ▼ E ⏻ ) to activate the browser screen.
2. Press M to enter the OSD screen.

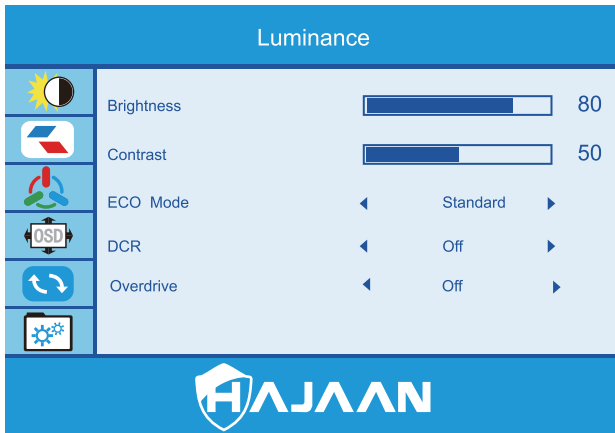

3. Press ▲ or ▼ to scroll through the functions.
  - Select the desired function, and press M to enter the sub-menu.
  - Press ▲ or ▼ to scroll through sub-menus, and press M key to select and confirm the desired function.
  - Press ▲ or ▼ to select one option, and press M to confirm settings and exit from the current menu.
4. Press E to exit from the menu screen.

Functions of the monitor vary with models, and the functions in this manual are for reference only.

Luminance	Brightness	0-100
	Contrast	0-100
	ECO Mode	Standard/Movie/ECO/User/RTS/FPS
	DCR	Off/On
	Overdrive	Off/On
Image Setup	H.Position	0-100 (Only VGA signal available)
	V.Position	0-100 (Only VGA signal available)
	Clock	0-100 (Only VGA signal available)
	Phase	0-100 (Only VGA signal available)
	Image Ratio	Wide/4:3
Color Setup	Color Temp.	Warm/Normal/Cool/User
	Red	0-100 (Only VGA signal available)
	Green	0-100 (Only VGA signal available)
	Blue	0-100 (Only VGA signal available)
	Low Blue Light	Off/Weak/Medium/Strong
OSD Setup	Language	15 Countries Language(Default:English)
	OSD H-Position	0-100
	OSD V-Position	0-100
	Time Out	5-100
	Transparence	0-100
Reset	Auto Config.	(Only VGA signal available)
	Auto Color	(Only VGA signal available)
	Reset	/
Extra	Input select	HDMI/VGA

# BASIC PARAMETERS

# 07

Product Name		23.8 inches monitor
Product model		S2424i
Screen Size		23.8 inches (60.45cm)
Aspect Ratio		16:9
Viewing Angle		≥178°(H) / ≥178°(V)
Display Area (H*V)		527.04(H)*296.46(V) mm
Contrast ratio		1000:1 (TYP)
Colors		16.7M
Resolution		1920*1080
Maximum refresh rate		75Hz
Power specifications		DC 12V $\approx$ 2.0A The standard voltage and current may vary with countries, please refer to the label at the back of the product.
Product Dimentions	Without base	541.2x321.2x41.4mm
	With base	541.2x425.3x178.2mm
Tilting angle		Forward titling: 5°±2°; Backward tilting: 15°±2°
Height range		NA
Rotation angle		NA
Vertical angle		NA
Environmental conditions	Action	Temperature: 0°C~ 40°C (32°F ~ 104°F) Humidity: 10%~90% RH (non-condensing)
	Storage	Temperature: -20° ~ 60° (-4°F ~ 140°F) Humidity: 5%~95% RH (non-condensing)

## THANK YOU FOR CHOOSING

